



Local Nonlinearity in S-cones and their Estimated Light-collecting Apertures

SHENG HE,*‡ DONALD I. A. MACLEOD†

Received 13 May 1996; in revised form 2 May 1997; in final form 11 August 1997

When an high frequency grating of high retinal contrast is presented intermittently by modulating its contrast at constant average luminance, observers experience uniform field flicker, even if the grating is too fine to be resolved. For long and middle wavelength cones, this contrast-modulation flicker can be seen for fringe periods as small as the diameter of a cone [MacLeod & He (1993). *Nature*, 361, 256–258], implying no substantial neural spatial integration prior to the nonlinear site. We now report that the short-wavelength cone system, despite its greater spatial integration than the other cone systems, can generate contrast-modulation flicker at spatial frequencies as high as 50 cycles/deg, a value comparable with that of the other cone systems in the same retinal area. Spatial resolution at the nonlinear site is in all cases apparently limited by the size of the cones. Likewise, little temporal filtering (in the range up to 18 Hz) precedes the S-cone nonlinearity. This suggests that the reduced S-cone system sensitivity for rapid flicker is due to postreceptoral limitations. © 1998 Elsevier Science Ltd. All rights reserved.

S-cones Nonlinearity Light adaptation Cone aperture

INTRODUCTION

We have demonstrated and studied an early, local nonlinear mechanism which appears to be the primary mechanism of light adaptation, using a phenomenon we call contrast-modulation flicker (MacLeod & He, 1993; He & MacLeod, 1998). Modulation of a stimulus contrast over time can be perceived as flicker of the whole field, even when the spatial average luminance level is kept constant. Contrast-modulation flicker is easily measurable in the L/M cone system (even with gratings as fine as 100 cycles/deg); yet consistent with many earlier experiments that suggested that adaptive adjustments of sensitivity in the rod system (Rushton, 1965; MacLeod, Chen & Crognale, 1989) are imposed at a postreceptoral pool rather than strictly locally within the rods themselves, we failed to show contrast-modulation flicker in the rod system. Like the rod system, the S-cone system is characterized by a wide range of spatial integration. Perceptual spatial resolution supported by the S-cone system was estimated to be around 10 cycles/deg by many different groups (Stiles, 1949; Brindley, 1954; Green, 1968; Kelly, 1973; Stromeyer, Kranda, & Sternheim, 1978; Williams *et al.*, 1982). This is about 5-times less than the resolution limit supported by the L/

M-cone system. On the other hand, at the same retinal site the physical dimensions of individual S-cones are not much different from L/M-cones, except that S-cones are about 20% fatter than L/M-cones at the sclerad (outer) part of their inner segment (Curcio, Allen, Sloan, Lerea, Hurley, Klock *et al.*, 1991). This makes it interesting to study contrast-modulation flicker in the S-cone system. Predictions about the spatial frequency dependence of S-cone contrast-modulation flicker are vastly different, depending on whether the nonlinear mechanism that underlies contrast-modulation flicker is before spatial integration (as in the L/M-cones) or after it (as in the rod system). If the nonlinear mechanism resides within S-cones or operates on signals from individual S-cones, as we found for L/M-cones, then the spatial frequency dependence of contrast-modulation flicker should not be much different for the S-cones and L/M-cones, being determined only by their optical aperture size. However, if the S-cone system is more similar to the rod system in its spatial properties of light adaptation, then contrast-modulation flicker would diminish much faster as a function of spatial frequency. Just as for our L/M-cone experiments, the first goal of this experiment is to study whether S-cones have a *local* nonlinear mechanism, and if they do, what are its temporal properties.

We might be able to go one step further if S-cones do have local light adaptation. Curcio *et al.* (1991) compared the S-cone inner segment diameter to that of L/M-cones sclerally and vitreally (see their Fig. 2). The S-cone inner segment is less tapered compared with that of L/M-cones. As a result, S-cone inner segment diameter is signifi-

*Department of Psychology, University of Minnesota, 75 East River Street, Minneapolis, MN 55455, U.S.A.

†Department of Psychology, University of California at San Diego, La Jolla, CA 92093, U.S.A.

‡To whom all correspondence should be addressed [Fax: 001 612 626 2079; Email: sheng@tc.umn.edu].

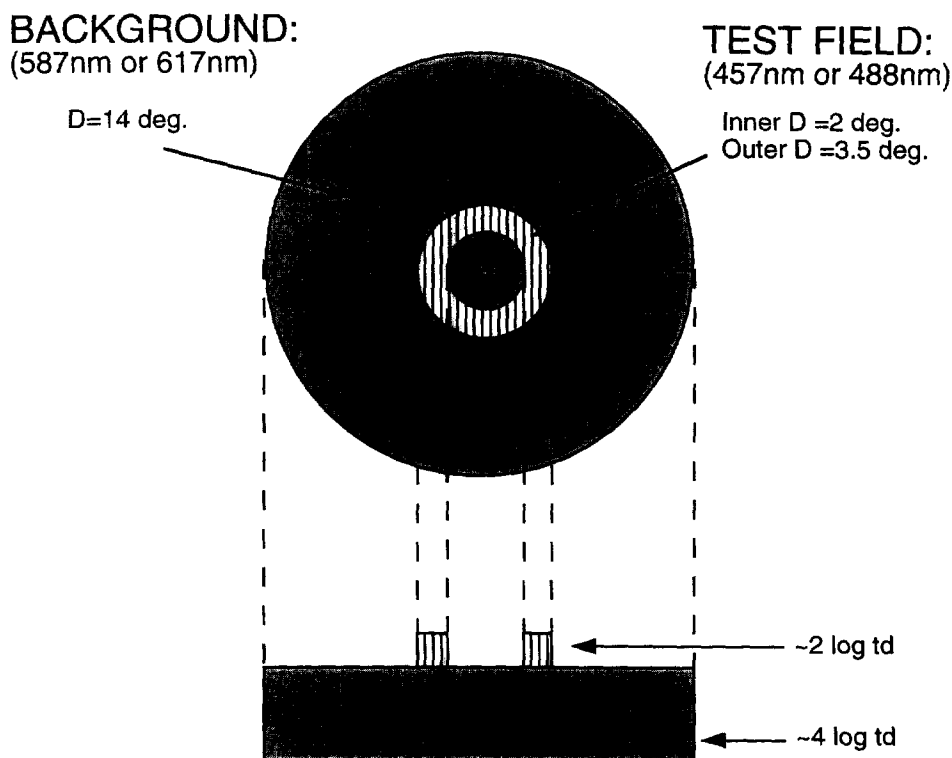

FIGURE 1. S-cone stimulus pattern. The selection of test field and background wavelength effectively isolated S-cones. See text for details.

cantly larger (about 20%) than that of the L/M-cones at their sclerad ends, while their vitread diameters are much closer, with the S-cone diameter even slightly smaller (Curcio *et al.*, 1991). Which one of these two places is the limiting aperture for light collection could be inferred from an estimate of the spatial aperture of the light adapting mechanism, given that this nonlinear mechanism is spatially limited by the cone optical aperture. So the rationale is: if the estimated aperture from contrast-modulation flicker measurement is about the same size for the S-cones and L/M-cones, then we would conclude that the vitread diameter is the limiting (bottle neck) aperture for light capture; if it turns out that the estimated aperture is significantly larger for S-cones than L/M-cones, then the sclerad diameter is more likely to be the limiting aperture.

PROCEDURE

The experiments reported here were conducted on a laser interferometer. Both the spatial frequency and contrast of the fringe pattern can be varied continuously and precisely under computer control. Spatial frequency of the fringe was determined by the separation between the two laser beams at the pupil entrance (Williams, 1985; Thibos, 1990). A detailed description of this instrument can be found in He and MacLeod (1996).

The contrast fluctuated sinusoidally between a peak value (generally unity) and zero. Our subjects saw flicker, as if the overall luminance of the field was changing, even though the total amount of light in the test field remained

constant during the modulation. This contrast-modulation flicker arises from a reduction in the perceived overall brightness of the field when the fringe comes on: we could cancel, or null it by making the overall luminance of the field fluctuate approximately in phase with the contrast modulation. At a suitably adjusted amplitude, the perceived flicker was minimized and the field appeared more or less steady. The nulling amplitude and phase provide an equivalent-input measure of contrast-modulation flicker.

The S-cone system was isolated using a short wavelength stimulus on a very intense long wavelength background. Figure 1 shows the arrangement and conditions of the stimulus. The source for the test grating was an Argon laser, which can generate output light at a series of different wavelengths. 457 nm (for normal subject SH) or 488 nm (for deuteranomalous subject DM) was selected with narrow-band interference filters. The background light was usually at 587 nm (for SH) or 617 nm (for DM). The reason for this wavelength selection is that DM's M-cone spectral sensitivity is very close to L-cones, hence his S-cones can still be easily isolated with 488 nm light on 617 nm background, and the same wavelength without background could be used to test his L and "M" cones. Thus, for subject SH, the test wavelength was changed from 457 nm for S-cones to 488 nm for L/M-cones; subject DM used 488 nm in both cases.

In order to compare the spatial resolution of the nonlinear mechanism that underlies contrast-modulation flicker in S-cones to that of L/M-cones, contrast-

modulation flicker was measured in S-cone isolation conditions, and also with L/M-cones in the same retinal area, using the same stimulus configuration but without the long wavelength background. Since S-cones are absent at the very center of the fovea (Williams, MacLeod & Hayhoe, 1981a; Curcio *et al.*, 1991), and the highest concentration of S-cones occurs on the foveal slope about 1 deg from the central fovea, with a rather gradual decrease beyond that (Curcio *et al.*, 1991), the stimulus was spatially configured as a ring with 2 deg inner diameter and 3.5 deg outer diameter centered on a 14 deg background (see Fig. 1). This way, the stimulus fell on the retina area with high and relatively uniform S-cone density. The average luminance of the test field was 2 log td, and the average luminance of the background was close to 4 log td. With the background, the effective peak contrast was at least 90% for the S-cones, and at most 1% for the L/M cones based on their spectral sensitivity (Smith & Pokorny, 1975; Stockman, MacLeod & Johnson, 1993a). S-cone isolation was assured by the observations that (1) the color of the field appeared violet; (2) gratings above 10 cycles/deg were not perceptually resolved; and (3) contrast-modulation flicker was observed in the area surrounding the fovea but not in the central fovea when tested with a small disk field. Isolation was aided by the fact that contrast-modulation flicker is generated only at high contrast. The amplitude of contrast-modulation flicker is roughly a quadratic function of the peak contrast (see Fig. 5 and also He & MacLeod, 1998).

We used the method which we term "pedestal-aided nulling", which exploits the fact that small differences in flicker amplitude around the just-detectable "threshold" amplitude, A , can be reliably detected even when the difference, δA , is much less than A (Henning, MacLeod and Stockman, unpublished). This procedure has been described in another paper (He & MacLeod, 1998). The basic idea of the procedure: the fringe pattern was presented in two temporal intervals (cancellation and reinforcing), each lasting for 1 sec. During both intervals, the contrast of the fringe pattern was modulated at a certain frequency, which presumably gives rise to a flicker signal with equivalent amplitude C' . The space average luminance level was also modulated in both intervals. In the cancellation interval, the luminance was modulated in phase with the contrast modulation (or in antiphase with the contrast-modulation flicker signal C' , since the underlying nonlinearity is approximately a compressive one), at amplitude $A+C'$; in the reinforcing interval, the space average luminance was modulated in antiphase with the contrast modulation (or in phase with flicker C') at amplitude $A - C'$. As a result, the flicker amplitude is $A+C - C'$ in the cancellation interval and $A - C+C'$ in the the reinforcing interval. The value for A was preset, usually at 35%, and subjects adjusted the value for C with a mouse trackball, to minimize the difference in flicker amplitude between the two intervals. When this condition is satisfied, C is equal to C' .

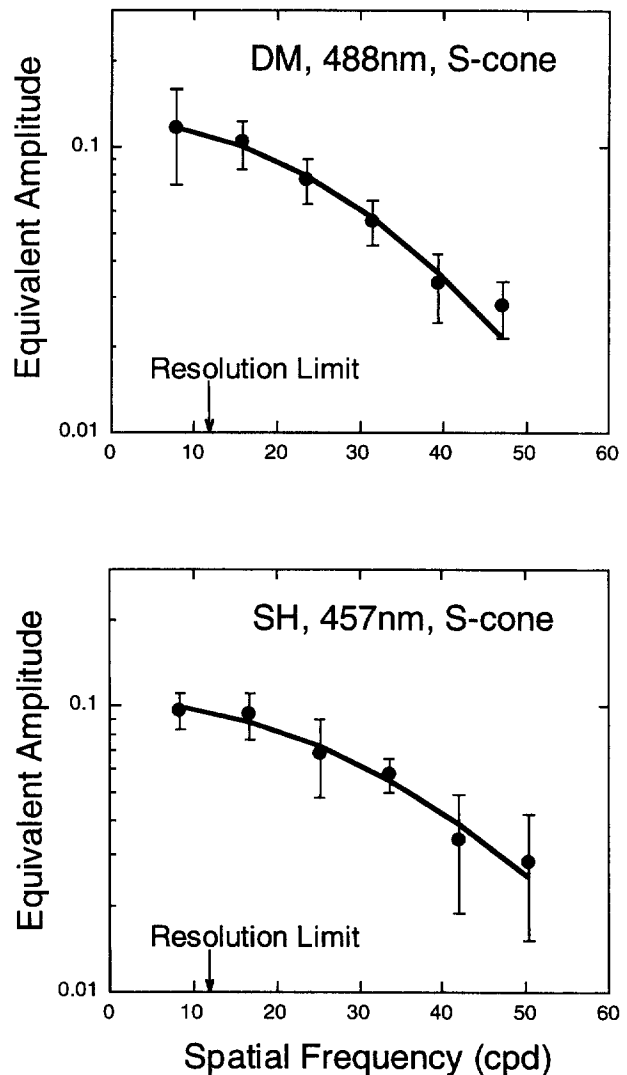

FIGURE 2. S-cone contrast-modulation flicker amplitude (filled circles) measured with nulling procedure on two observers. Continuous curves are the best-fitting gaussians. Contrast-modulation flicker decreases slowly as a function of spatial frequency, and could still be measured with gratings even at 50 cpd, about 5-times the S-cone resolution limit.

RESULTS AND DISCUSSION

Spatial resolution and anatomical comparisons

Contrast-modulation flicker was clearly demonstrable in S-cone vision, even when the grating's frequency was far above the S-cone resolution limit. In fact, in the same parafoveal area the equivalent (nulling) amplitudes for the S-cones are in the same range (about 10% around the S-cone visual resolution limit) as those for the L/M cones, and the cut-off spatial frequencies are also similar for different cone systems (about 50 cpd, 5-times the S-cone visual resolution limit, see Fig. 2). Contrast-modulation flicker from L/M-cones was measured at the same retinal area simply by eliminating the background (Fig. 3). These results show that the responsible nonlinearity in the S-cone system is also strictly local. Based on the spatial frequency dependence of contrast-modulation flicker amplitude, the contrast attenuation at

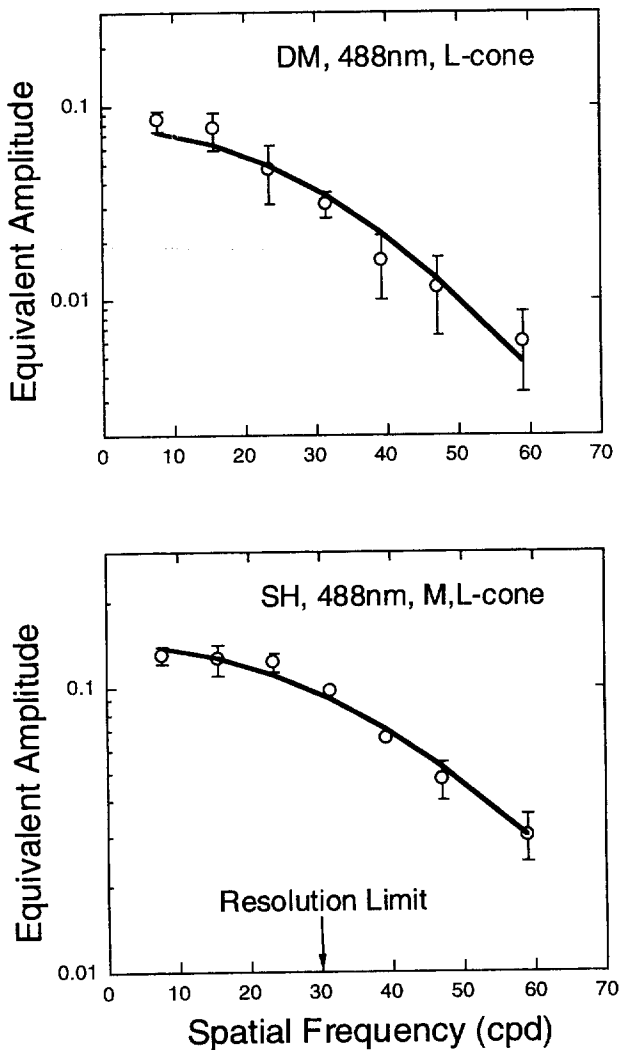

FIGURE 3. *L/M*-cone contrast-modulation flicker amplitude (open circles) measured at the same parafoveal retinal areas as that of *S*-cone. Solid curves are the best-fitting Gaussians. The functions relating contrast-modulation flicker to spatial frequency are very similar for *S*-cones and *L/M*-cones.

each spatial frequency before the nonlinear site could be estimated as the square root of the contrast-modulation flicker amplitude (MacLeod, Williams & Makous, 1992; He & MacLeod, 1998). By taking the Fourier transform of a Gaussian fit to the estimated contrast (spatial frequency) function, we can obtain an estimated Gaussian point spread function for transmission up to the nonlinear site for *S*-cones and *L/M*-cones in the same parafoveal area (Fig. 4, also see Appendix of He & MacLeod, 1998). The full widths at half height are 3.84 microns for both *S*-cones and *L/M*-cones. These estimates are again a little less than the vitread *S*-cone and *L/M*-cone inner segment diameters obtained anatomically. Table 1 shows the estimated full width at half-height of the point spread function for the two observers and compares that with the anatomical cone size.

As indicated in the bottom half of Table 1, Curcio *et al.* (1991) found, by staining for antibodies to blue cone opsin, that while the outer (sclerad) portions of the *S*-cone inner segments are some 20% fatter than those of *L*/

Estimated Gaussian Apertures Based on Averaged CMF Data From DM,SH

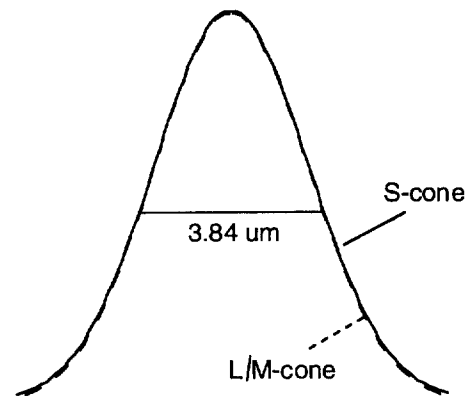

FIGURE 4. Point spread function for the input to the nonlinear element in parafoveal areas for *S*-cones (solid line) and *L/M*-cones (dashed line). The Gaussian apertures were derived from the data in Figs 2 and 3, as explained in the Appendix of He and MacLeod (1997). The Gaussian apertures for the different cones are almost identical.

M cones, the inner (vitread) portions are much less different compared with other cones. From Table 1, it follows that the inner diameter (closer to the vitread end) of cone inner segments is more likely to be the functionally relevant dimension for light capture.

We derived our aperture estimation based on experiments using coherent light; the lack of accurate knowledge about how light propagates through the photoreceptor matrix prevents us from generating the results to incoherent illumination (MacLeod *et al.*, 1992).

Implications for sensitivity

It is widely agreed on the basis of psychophysical and anatomical evidence that the *S* cones are only a few percent of total cone population. On that assumption, Williams, MacLeod, and Hayhoe (1981b) calculated that the sensitivity of the *S* cone system, in terms of absorbed quanta required to reach visual threshold, is much greater than that of the *L* and *M* cone systems, and approaches that of the rod system. This conclusion presupposed a similar effective aperture for the *S*, *L* and *M* cones, and

TABLE 1. Estimated width of the nonlinear mechanism and the anatomically measured cone sizes (μm)

Observer	Psychophysics (current experiment)	
	<i>S</i> -cones	<i>L/M</i> -cones
DM	4.12	4.36
SH	3.55	3.31
Average	3.84	3.84
Anatomy (from Curcio <i>et al.</i> , 1991)		
Relative position	<i>S</i> -cones	<i>L/M</i> -cones
Sclerad	4.1	3.4
Vitread	5.1	5.4

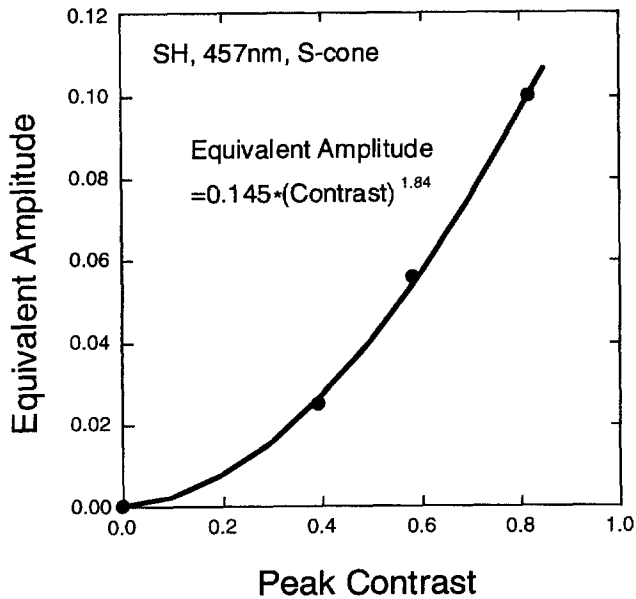

FIGURE 5. S-cone contrast-modulation flicker amplitude as a function of peak contrast. The data were fitted with a power function with the exponent as a free parameter. As with L/M-cones, contrast-modulation flicker is roughly a quadratic function of peak contrast.

the present results support that assumption and the surprising conclusion based on it. No physiological basis for this superiority in sensitivity is yet forthcoming.

Contrast dependence

A quadratic relation between contrast-modulation flicker and peak contrast was assumed in the above estimates of contrast sensitivity at the nonlinear site. We tested this point specifically for S-cones using a stimulus

of 10 cpd. Figure 5 shows the result. As with L/M-cones (He & MacLeod, 1998), contrast-modulation flicker amplitude increases roughly as a function of peak contrast squared (a least squares fit with a power function gave an exponent of 1.84). We showed why this is expected for a smooth nonlinearity in another paper (He & MacLeod, 1998).

Intensity dependence

This nonlinear mechanism does not require high light levels to come into play. Figure 6 shows that contrast-modulation flicker amplitude was only reduced about 30% when the luminance was reduced from 200 to 20 td, a factor of 10 reduction in light level. The range of adaptation over which the local nonlinear mechanism is active corresponds well with the range over which sensitivity adjustments are found in psychophysical increment thresholds.

Dynamics

As in the case of L/M-cones (He & MacLeod, 1998), S-cone contrast-modulation flicker cannot be explained by an instantaneous compressive nonlinearity nor by a sluggish feedback sensitivity control model, since the nulling luminance modulation has to anticipate slightly the modulation of contrast at low frequency and decreases as the frequency increases (Fig. 7), in this case crossing zero around 10 Hz. If we interpret this in terms of our fast sensitivity-scaling model (He & MacLeod, 1998), the data suggest that the delay for the S-cone sensitivity control mechanism is roughly 50 msec (half period = 10 Hz), since it is when sensitivity fluctuations come into phase with contrast fluctuations (thanks to a delay of one half-cycle) that the nulling luminance comes

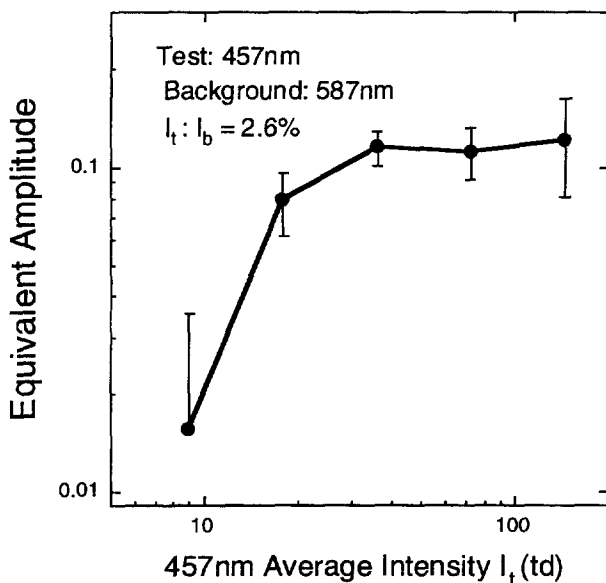

FIGURE 6. S-cone contrast-modulation flicker amplitude measured at different mean test luminance levels at a spatial frequency of 10 cpd. Background to test field luminance ratio was kept constant, thus the S-cone peak contrast was not changed with mean luminance level change.

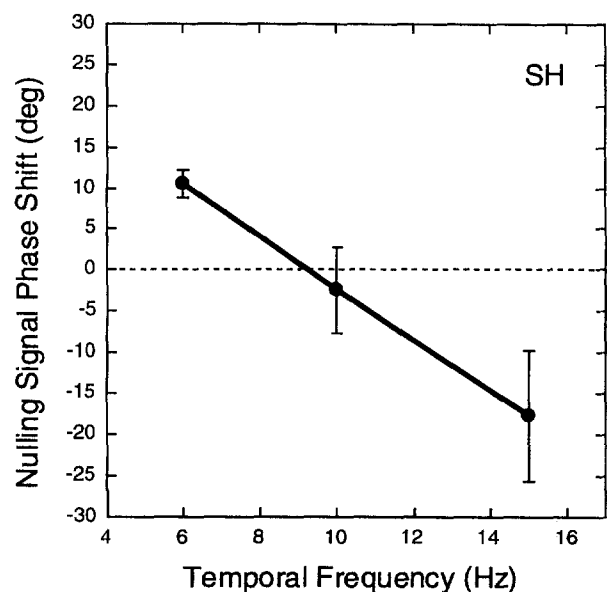

FIGURE 7. Temporal phase of luminance modulation required to cancel S-cone contrast-modulation flicker perceptually at three temporal frequencies, measured at a spatial frequency of 10 cpd. Positive phase values mean the luminance peak had to precede the contrast peak.

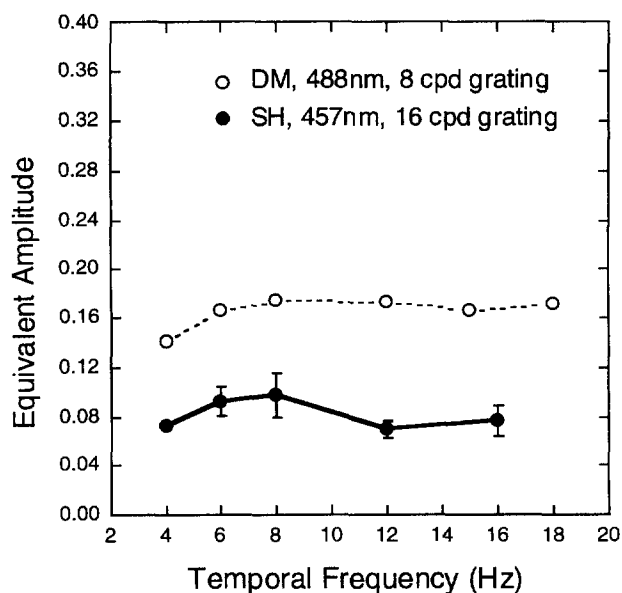

FIGURE 8. S-cone contrast-modulation flicker amplitude measured at a range of temporal frequencies. There is no evidence for temporal filtering up to the highest temporal frequencies (18 Hz) we tested.

into opposite phase with both. The 50 msec value is longer than the value of about 20 msec we obtained for the L/M cones, but of the same order of magnitude. A further similarity between S-cone and L/M-cone systems is that S-cone contrast-modulation flicker amplitude does not depend very much on modulation frequency in the range (4–18 Hz) that we tested, as shown in Fig. 8. These results together suggest that the underlying nonlinear mechanism for S-cones is very similar to that of L/M-cones: both could be well explained by a relatively fast sensitivity-regulating process that scales sensitivity roughly in inverse proportion to recent input levels, albeit with different parameter values in the case of S-cones.

Temporal vs spatial demodulation in the S cone system

The current experiment demonstrated a spatially local nonlinear mechanism in the S-cone system. An early S-cone nonlinearity was also evident in a study by Stockman, MacLeod and LeBrun (1993b) where they observed a color change phase-locked with the envelope of an amplitude-modulated S-cone flicker stimulus, even when the flicker itself was too rapid to be perceived as such, a violation of Talbot–Plateau law. Their experiments revealed an S-cone nonlinearity preceding some temporal integration, whereas ours reveal one preceding all neural spatial integration, but both could depend on the same nonlinear mechanism.

Contrast-modulation flicker amplitude remains almost unchanged up to 18 Hz. This is the behavior expected if the underlying sensitivity adjustment is imposed either very rapidly or very slowly, but the need for significant phase deviations from opposite phase under the null condition excludes the very slow adaptation model. The observation that nulling amplitude hardly varies with temporal frequency is not inconsistent with the presence

of severe temporal filters before or (as the observations of Stockman *et al.* suggest) after the nonlinear element in the S cone system, since these effects tend to cancel in the nulling measure we employed (as explained in He & MacLeod, 1998).

Conclusions

Our results show that although S-cones differ from L/M-cones in many ways, they all have a local and fast sensitivity control mechanism not found in the rod system. As with the L/M cones, the resolution of the sensitivity-controlling mechanism is limited only by the optical aperture of cone photoreceptors; and this appears to be determined by the vitread portion of the inner segment.

REFERENCES

- Brindley, G. S. (1954). The summation areas of human colour-receptive mechanisms at increment threshold. *Journal of Physiology (London)*, 124, 400–408.
- Curcio, C. A., Allen, K. A., Sloan, K. R., Lerea, C. L., Hurley, J. B., Klock, I. B. & Milam, A. H. (1991). Distribution and morphology of human cone photoreceptors stained with anti-blue opsin. *Journal of Comparative Neurology*, 312, 610–624.
- Green, D. G. (1968). The contrast sensitivity of the colour mechanisms of the human eye. *Journal of Physiology (London)*, 222, 419–426.
- He, S. & MacLeod, D. I. A. (1996). Local luminance nonlinearity and receptor aliasing in the detection of high frequency gratings. *Journal of the Optical Society of America*, A13, 1139–1151.
- He, S. & MacLeod, D. I. A. (1998). Contrast-modulation flicker: dynamics and spatial resolution of the light adaptation process. *Vision Research*, 38, 985–1000.
- Kelly, D. H. (1973). Lateral inhibition in human colour mechanisms. *Journal of Physiology (London)*, 228, 55–72.
- MacLeod, D. I. A., Chen, B. & Crognale, M. (1989). Spatial organization of sensitivity regulation in rod vision. *Vision Research*, 29, 965–978.
- MacLeod, D. I. A. & He, S. (1993). Visible flicker from invisible patterns. *Nature*, 361, 256–258.
- MacLeod, D. I. A., Williams, D. R. & Makous, W. (1992). A visual nonlinearity fed by single cones. *Vision Research*, 32, 347–363.
- Rushton, W. A. H. (1965). Visual adaptation. The Ferrier lecture. *Proceedings of the Royal Society of London*, B162, 20–46.
- Stiles, W. S. (1949). Increment thresholds and the mechanisms of colour vision. *Documenta Ophthalmologica*, 3, 138–163.
- Stockman, A., MacLeod, D. I. A. & LeBrun, S. (1993b) Faster than the eye can see: blue cones respond to rapid flicker. *Journal of the Optical Society of America*, A10, 1396–1402.
- Stromeyer, C. F. III, Kranda, K. & Sternheim, C. E. (1978). Selective chromatic adaptation at different spatial frequencies. *Vision Research*, 18, 428–438.
- Thibos, L. N. (1990). Optical limitations of the Maswellian view interferometer. *Applied Optics*, 29, 1411–1419.
- Williams, D. R. (1985). Aliasing in human foveal vision. *Vision Research*, 25, 195–205.
- Williams, D. R., MacLeod, D. I. A. & Hayhoe, M. M. (1981a) Foveal tritanopia. *Vision Research*, 19, 1341–1356.
- Williams, D., MacLeod, D. I. A. & Hayhoe, M. (1981b) Punctate sensitivity of the blue sensitive mechanism. *Vision Research*, 21, 1357–1375.

Acknowledgements—Part of this work has been reported at the 1992 Annual Meeting of Optical Society of America, Albuquerque, New Mexico. We thank Dr Andrew Stockman for his help in setting up the equipment. Supported by NIH grant EY01711.